

# RedLab 1608FS

USB-based Analog and Digital I/O Module

## User's Guide



# **RedLab 1608FS**

## **USB-based Analog and Digital I/O Module**

### **User's Guide**



Document Revision 1.4 E, January, 2008  
© Copyright 2008, Meilhaus Electronic™

# Imprint

## **User's Guide RedLab® Series**

Document Revision 1.4 E  
Revision Date: January 2008

Meilhaus Electronic GmbH

Fischerstraße 2  
D-82178 Puchheim near Munich, Germany  
<http://www.meilhaus.de>

© Copyright 2008 Meilhaus Electronic GmbH

All rights reserved. No part of this publication may be reproduced, stored in a retrieval system, or transmitted, in any form by any means, electronic, mechanical, by photocopying, recording, or otherwise without the prior written permission of Meilhaus Electronic GmbH.

## **Important note:**

All the information included in this user's guide were put together with utmost care and to best knowledge. However, mistakes may not have been erased completely.

For this reason, the firm Meilhaus Electronic GmbH feels obliged to point out that they cannot be take on neither any warranty (apart from the claims for warranty as agreed) nor legal responsibility or liability for consequences caused by incorrect instructions.

We would appreciate it if you inform us about any possible mistakes.

The trademark Personal Measurement Device, TracerDAQ, Universal Library, InstaCal, Harsh Environment Warranty, Measurement Computing Corporation, and the Measurement Computing logo are either trademarks or registered trademarks of Measurement Computing Corporation.

Windows, Microsoft, and Visual Studio are either trademarks or registered trademarks of Microsoft Corporation.

LabVIEW is a trademark of National Instruments.

CompactFlash is a registered trademark of SanDisk Corporation.

XBee is a trademark of MaxStream, Inc.

All other trademarks are the property of their respective owners.

---

# Table of Contents

## Preface

<b>About this User's Guide .....</b>	<b>6</b>
What you will learn from this user's guide .....	6
Conventions in this user's guide .....	6
Where to find more information .....	6

## Chapter 1

<b>Introducing the RedLab 1608FS .....</b>	<b>7</b>
RedLab 1608FS block diagram .....	8
Software features .....	8
Connecting a RedLab 1608FS to your computer is easy .....	9

## Chapter 2

<b>Installing the RedLab 1608FS .....</b>	<b>10</b>
What comes with your RedLab 1608FS shipment? .....	10
Hardware .....	10
Additional documentation .....	10
Unpacking the RedLab 1608FS .....	11
Installing the software .....	11
Installing the hardware .....	11

## Chapter 3

<b>Functional Details .....</b>	<b>13</b>
Theory of operation - analog input acquisition modes .....	13
Software paced mode .....	13
Continuous scan mode .....	13
Burst scan mode .....	13
External components .....	14
USB connector .....	14
LED .....	14
Screw terminal wiring .....	15
Main connector and pin out .....	16
Analog input terminals (CH0 IN - CH7 IN) .....	16
Digital I/O terminals (DIO0 to DIO7) .....	17
Power terminals .....	18
Ground terminals .....	18
Calibration terminal .....	19
Counter terminal .....	19
SYNC terminal .....	19
Trigger terminal .....	19
Accuracy .....	19
Gain queue .....	22
Synchronizing multiple units .....	23

## Chapter 4

<b>Specifications .....</b>	<b>24</b>
Analog input section .....	24
Digital input/output .....	25
External trigger .....	26
External clock input/output .....	26
Counter section .....	27
Memory .....	27
Microcontroller .....	27

Power.....	27
General .....	28
Environmental .....	28
Mechanical .....	28
Main connector and pin out.....	28

---

## About this User's Guide

### What you will learn from this user's guide

This user's guide explains how to install, configure, and use the RedLab 1608FS so that you get the most out of its USB data acquisition features.

This user's guide also refers you to related documents available on our web site, and to technical support resources.

### Conventions in this user's guide

**For more information on ...**

Text presented in a box signifies additional information and helpful hints related to the subject matter you are reading.

**Caution!** Shaded caution statements present information to help you avoid injuring yourself and others, damaging your hardware, or losing your data.

<#:#> Angle brackets that enclose numbers separated by a colon signify a range of numbers, such as those assigned to registers, bit settings, etc.

**bold text** **Bold** text is used for the names of objects on the screen, such as buttons, text boxes, and check boxes. For example:

1. Insert the disk or CD and click the **OK** button.

*italic text* *Italic* text is used for the names of manuals and help topic titles, and to emphasize a word or phrase. For example:

The *InstaCal* installation procedure is explained in the *Quick Start Guide*.  
*Never* touch the exposed pins or circuit connections on the board.

### Where to find more information

The following electronic documents provide helpful information relevant to the operation of the RedLab 1608FS.

- The *Quick Start Guide* is available on our RedLab CD in the root directory.
- The *Guide to Signal Connections* is available on our RedLab CD under „ICalUL\Documents“.
- The *Universal Library User's Guide* is available on our RedLab CD under „ICalUL\Documents“.
- The *Universal Library Function Reference* is available on our RedLab CD under „ICalUL\Documents“.
- The *Universal Library for LabVIEW™ User's Guide* is available on our RedLab CD under „ICalUL\Documents“.

---

## Introducing the RedLab 1608FS

This user's guide contains all of the information you need to connect the RedLab 1608FS to your computer and to the signals you want to measure. The RedLab 1608FS is part of the Meilhaus Electronic brand of USB-based data acquisition products.

The RedLab 1608FS is a USB 2.0 full-speed device supported under popular Microsoft® Windows® operating systems. It is designed for USB 1.1 ports, and was tested for full compatibility with both USB 1.1 and USB 2.0 ports.

The RedLab 1608FS offers true simultaneous sampling of up to eight channels of 16-bit single-ended analog input. This is accomplished through the use of one A/D converter per channel. The range of each channel is independently configurable via software. Eight digital IO lines are independently selectable as input or output. A 32-bit counter is capable of counting TTL pulses. The RedLab 1608FS is powered by the +5 volt USB supply from your computer. No external power is required.

A SYNC (synchronization) control line allows you to synchronize two RedLab 1608FS modules together to acquire data synchronously from 16 analog inputs.

The RedLab 1608FS is shown in Figure 1. I/O connections are made to the screw terminals located along each side of the RedLab 1608FS.



Figure 1. RedLab 1608FS

## RedLab 1608FS block diagram

RedLab 1608FS functions are illustrated in the block diagram shown here.

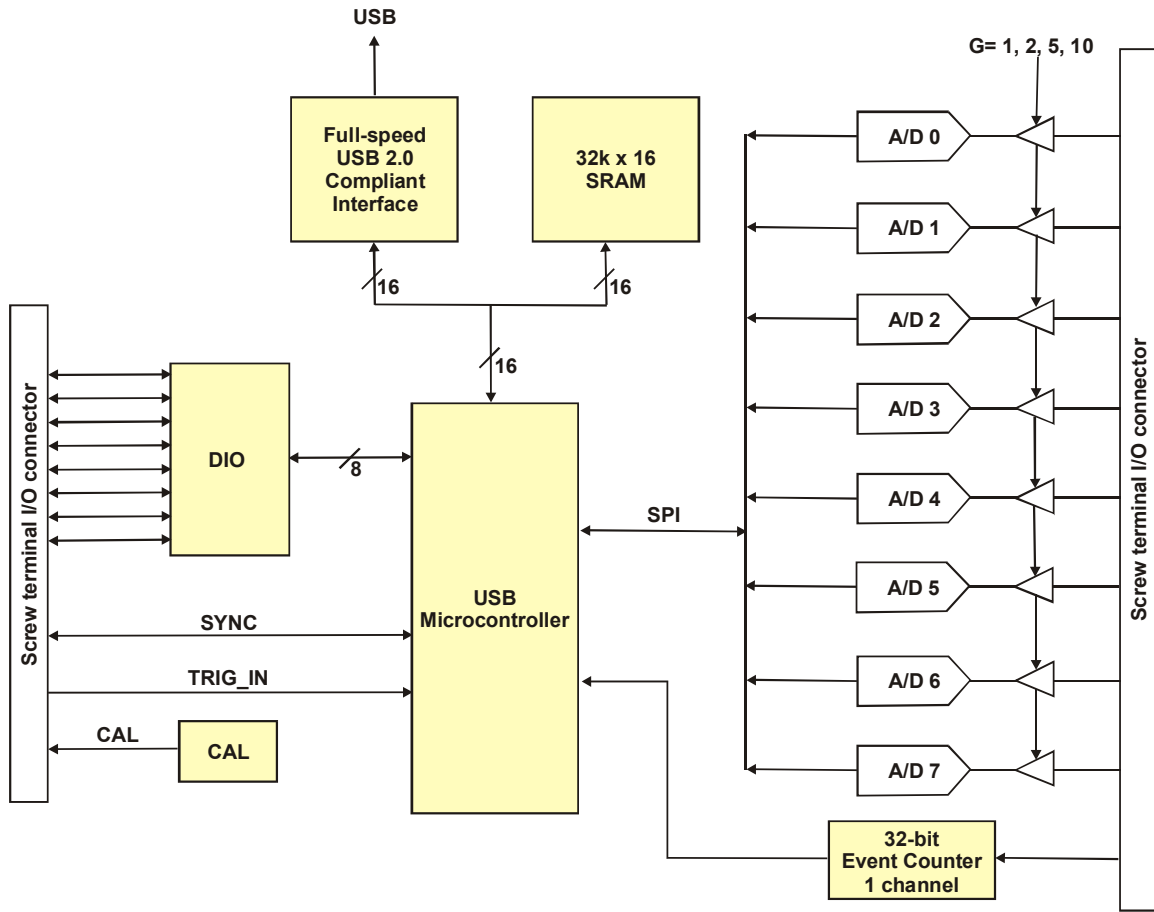

Figure 2. RedLab 1608FS Functional Block Diagram

## Software features

For information on the features of *InstaCal* and the other software included with your *RedLab 1608FS*, refer to the *Quick Start Guide* that shipped with your device. The *Quick Start Guide* is also available in PDF on our RedLab CD (root directory).

## **Connecting a RedLab 1608FS to your computer is easy**

Installing a data acquisition device has never been easier.

- The RedLab 1608FS relies upon the Microsoft Human Interface Device (HID) class drivers. The HID class drivers ship with every copy of Windows that is designed to work with USB ports. We use the Microsoft HID because it is a standard, and its performance delivers full control and maximizes data transfer rates for your RedLab 1608FS. No third-party device driver is required.
- The RedLab 1608FS is plug-and-play. There are no jumpers to position, DIP switches to set, or interrupts to configure.
- You can connect the RedLab 1608FS before or after you install the software, and without powering down your computer first. When you connect an HID to your system, your computer automatically detects it and configures the necessary software. You can connect and power multiple HID peripherals to your system using a USB hub.
- You can connect your system to various devices using a standard four-wire cable. The USB connector replaces the serial and parallel port connectors with one standardized plug and port combination.
- You do not need a separate power supply module. The USB automatically delivers the electrical power required by each peripheral connected to your system.
- Data can flow two ways between a computer and peripheral over USB connections.

---

# Installing the RedLab 1608FS

## What comes with your RedLab 1608FS shipment?

The following items are shipped with the RedLab 1608FS.

### Hardware

- RedLab 1608FS



- USB cable (2 meter length)



### Additional documentation

In addition to this hardware user's guide, you should also receive the *Quick Start Guide* (available on our RedLab CD (root directory)). This booklet supplies a brief description of the software you received with your RedLab 1608FS and information regarding installation of that software. Please read this booklet completely before installing any software or hardware.

## Unpacking the RedLab 1608FS

As with any electronic device, you should take care while handling to avoid damage from static electricity. Before removing the RedLab 1608FS from its packaging, ground yourself using a wrist strap or by simply touching the computer chassis or other grounded object to eliminate any stored static charge.

If your RedLab 1608FS is damaged, notify Meilhaus Electronic immediately by phone, fax, or e-mail. For international customers, contact your local distributor where you purchased the RedLab 1608FS.

- Phone: +49 (0) 89/8901660
- Fax: +49 (0) 89/89016628
- E-Mail: support@meilhaus.com

## Installing the software

Refer to the *Quick Start Guide* for instructions on installing the software *Guide* (available on our RedLab CD (root directory)).

## Installing the hardware

### Be sure you are using the latest system software

Before you connect the RedLab 1608FS, make sure that you are using the latest versions of the USB drivers.

Before installing the RedLab 1608FS, download and install the latest Microsoft Windows updates. In particular, when using Windows XP, make sure you have XP Hotfix KB822603 installed. This update is intended to address a serious error in Usbport.sys when you operate a USB device. You can run Windows Update or download the update from [www.microsoft.com/downloads/details.aspx?familyid=733dd867-56a0-4956-b7fe-e85b688b7f86&displaylang=en](http://www.microsoft.com/downloads/details.aspx?familyid=733dd867-56a0-4956-b7fe-e85b688b7f86&displaylang=en). For more information, refer to the Microsoft Knowledge Base article "Availability of the Windows XP SP1 USB 1.1 and 2.0 update." This article is available at [support.microsoft.com/?kbid=822603](http://support.microsoft.com/?kbid=822603).

To connect the RedLab 1608FS to your system, turn your computer on, and connect the USB cable to a USB port on your computer or to an external USB hub that is connected to your computer. The USB cable provides power and communication to the RedLab 1608FS.

The RedLab 1608FS installs as a composite device with separate devices attached. When you connect the RedLab 1608FS for the first time, **Found New Hardware** popup balloons (Windows XP) or dialogs (other Windows version) open as each RedLab 1608FS interface is detected.

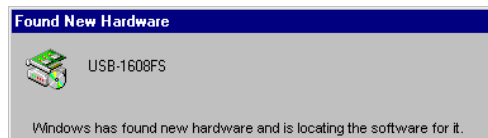
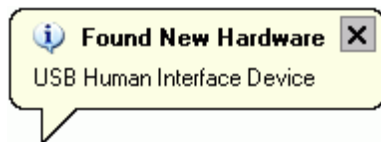

It is normal for multiple dialogs to open when you connect the RedLab 1608FS for the first time. For additional information, refer to the "Notes on installing and using the RedLab 1608FS" that was shipped with the RedLab 1608FS.

When the last balloon or dialog closes, the installation is complete. The LED on the RedLab 1608FS should flash and then remain lit. This indicates that communication is established between the RedLab 1608FS and your computer.

**Caution!** Do not disconnect **any** device from the USB bus while the computer is communicating with the RedLab 1608FS, or you may lose data and/or your ability to communicate with the RedLab 1608FS.

**If the LED turns off**

If the LED is lit but then turns off, the computer has lost communication with the RedLab 1608FS. To restore communication, disconnect the USB cable from the computer, and then reconnect it. This should restore communication, and the LED should turn back *on*.

---

## Functional Details

### Theory of operation - analog input acquisition modes

The RedLab 1608FS can acquire analog input data in three basic modes – software paced, continuous scan, and burst scan.

#### Software paced mode

You can acquire one analog sample at a time in software paced mode. You initiate the A/D conversion by calling a software command. The analog value is converted to digital data and returned to the computer. You can repeat this procedure until you have the total number of samples that you want from one channel.

The maximum throughput sample rate in software paced mode is system-dependent.

#### Continuous scan mode

You can acquire data from up to eight channels simultaneously in continuous scan mode. The analog data is continuously acquired, converted to digital values, and written to an on-board FIFO buffer on the RedLab 1608FS until you stop the scan. The FIFO buffer is serviced in blocks as the data is transferred from the RedLab 1608FS FIFO buffer to the memory buffer on your computer.

The maximum sampling rate is an aggregate rate, where the total sample rate for all channels is 100 kS/s divided by the number of channels, with a maximum rate of 50 kS/s for any channel. Using this equation, you can acquire data with the RedLab 1608FS from one channel at 50 kS/s, two channels at 50 kS/s each, four channels at 25 kS/s each, and so on, up to eight channels at 12.5 kS/s each. You can start a continuous scan with either a software command or with an external hardware trigger event.

#### Burst scan mode

In burst scan mode, you can acquire data with the RedLab 1608FS using the full capacity of its 32 K sample FIFO. The acquired data is then read from the FIFO and transferred to a user buffer in your computer. You can initiate a single acquisition sequence of one, two, four, or eight channels by either a software command or an external hardware trigger.

Burst scans are limited to the depth of the on-board memory, as the data is acquired at a rate faster than it can be transferred to the computer. The maximum sampling rate is an aggregate rate, where the total acquisition rate for all channels is 200 kS/s divided by the number of channels, with a maximum rate of 50 kS/s for any channel. The maximum rate that you can acquire data using burst scan mode is 50 kS/s each for one, two, or four channels, and 25 kS/s each for eight channels.

## External components

The RedLab 1608FS has the following external components, as shown in Figure 3.

- USB connector
- LED
- Screw terminal banks (2)

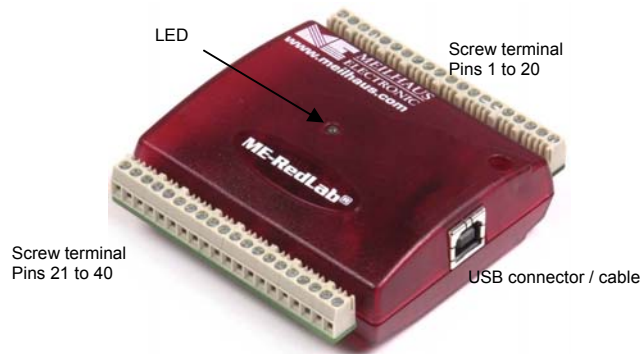

Figure 3. RedLab 1608FS

### USB connector

The USB connector is on the right side of the RedLab 1608FS. This connector provides +5 V power and communication. The voltage supplied through the USB connector is system-dependent, and may be less than 5 V. No external power supply is required.

### LED

The LED on the front of the RedLab 1608FS indicates the communication status. It uses up to 5 mA of current and cannot be disabled. The table below explains the function of the RedLab 1608FS LED.

LED Illumination

When the LED is...	It indicates...
Steady green	The RedLab 1608FS is connected to a computer or external USB hub.
Blinks continuously	Data is being transferred.
Blinks three times	Initial communication is established between the RedLab 1608FS and the computer.
Blinks at a slow rate	The analog input is configured for external trigger. The LED stops blinking and illuminates steady green when the trigger is received.

## Screw terminal wiring

The RedLab 1608FS has two rows of screw terminals—one row on the top edge of the housing, and one row on the bottom edge. Each row has 20 connections. Pin numbers are identified in Figure 4.



Figure 4. RedLab 1608FS screw terminal pin numbers

### Screw terminal – pins 1-20

The screw terminals on the top edge of the RedLab 1608FS (pins 1 to 20) provide the following connections:

- Eight analog input connections (**CH0 IN** to **CH7 IN**)
- Eleven analog ground connections (**AGND**)
- One calibration output terminal (**CAL**)

### Screw terminal – pins 21-40

The screw terminals on the bottom edge of the RedLab 1608FS (pins 21 to 40) provide the following connections:

- Eight digital I/O connections (**DIO0** to **DIO7**)
- One external trigger source (**TRIG\_IN**)
- One external event counter connection (**CTR**)
- One power connection (**PC+5 V**)
- One SYNC terminal for external clocking and multi-unit synchronization (**SYNC**)
- Eight ground connections (**GND**)

### Main connector and pin out

Connector type	Screw terminal
Wire gauge range	16 AWG to 30 AWG

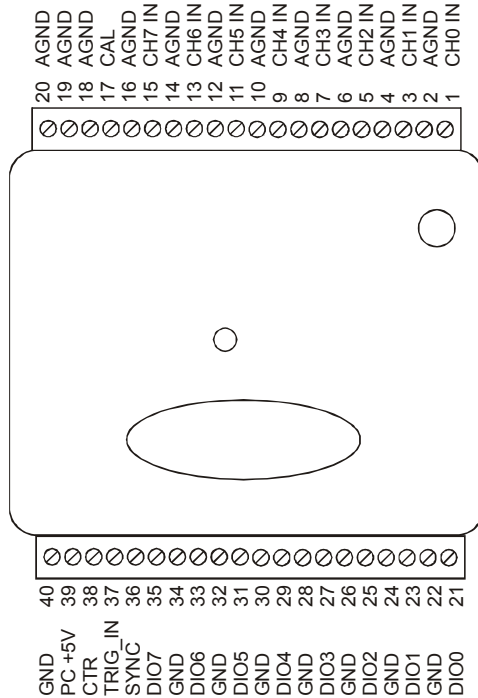

### Analog input terminals (CH0 IN - CH7 IN)

You can connect up to eight analog input connections to the screw terminal containing pins 1 to 20 (**CH0 IN** through **CH7 IN**.) Refer to the pinout diagram on page 3-16 for the location of these pins. We recommend that you connect unused analog input terminals to ground terminals during operation. For example, if you are not using terminal 15 (CH7 IN), connect this terminal to terminal 16 (AGND).

### Input configuration

All of the analog input channels are configured for single-ended input mode. Each analog signal is referenced to signal ground (AGND), and requires two wires:

- The wire carrying the signal to be measured connects to CH# IN.
- The second wire connects to AGND.

The input voltage ranges are  $\pm 10$  V,  $\pm 5$  V,  $\pm 2.0$  V,  $\pm 1.0$  V. The following image illustrates a typical single-ended measurement connection.

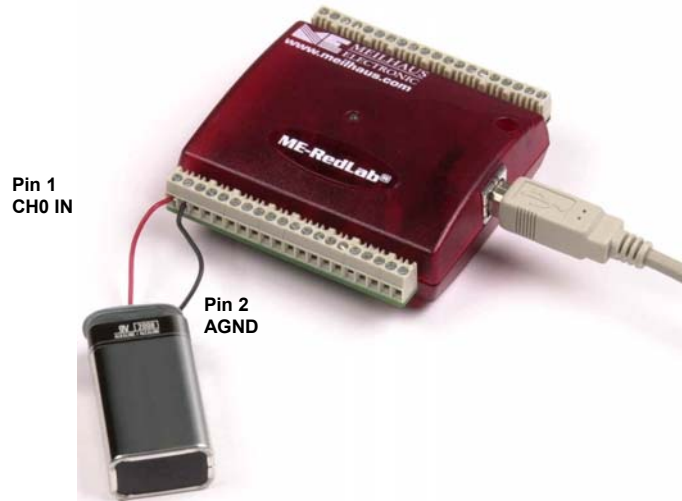

Figure 5. Single-Ended measurement connection

#### For more information on analog signal connections

For more information on single-ended inputs, refer to the *Guide to Signal Connections* (this document is available on our RedLab CD (root directory)).

### Digital I/O terminals (DIO0 to DIO7)

You can connect up to eight digital I/O lines to the screw terminal containing pins 21 to 40 (**DIO0** to **DIO7**). Refer to the pinout diagram on page 3-16 for the location of these pins. You can configure each digital bit for either input or output. All digital I/O lines are pulled up to USB +5 V with a 47 K resistor (default). You can request the factory to configure the resistor for pull-down to ground if desired.

When you configure the digital bits for input, you can use the RedLab 1608FS digital I/O terminals to detect the state of any TTL-level input. Refer to the switch circuit shown in Figure 6 and the schematic shown in Figure 7. If you set the switch to the +5 V input, DIO0 reads *TRUE* (1). If you move the switch to GND, DIO0 reads *FALSE* (0).

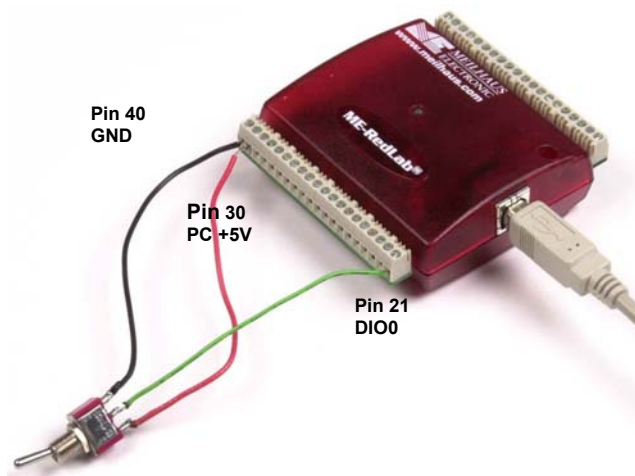

Figure 6. Digital connection DIO0 detecting the state of a switch

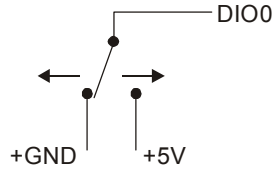

Figure 7. Schematic showing switch detection by digital channel DIO0

#### For more information on digital signal connections

For general information regarding digital signal connections and digital I/O techniques, refer to the *Guide to Signal Connections* (available on our RedLab CD (root directory)).

## Power terminals

The **PC +5 V** connection (pin 39) is on the bottom screw terminal of the RedLab 1608FS. Refer to the pinout diagram on page 3-16 for the location of this pin. This terminal draws power from the USB connector. The +5 V screw terminal is a 5 volt output that is supplied by the computer.

**Caution!** The +5 V terminal is an output. Do not connect to an external power supply or you may damage the RedLab 1608FS and possibly the computer.

The maximum total output current that can be drawn from all RedLab 1608FS connections (power, analog, and digital outputs) is 500 mA. This maximum applies to most personal computers and self-powered USB hubs. Bus-powered hubs and notebook computers may limit the maximum available output current to 100 mA.

The RedLab 1608FS alone draws 150 mA of current from the USB +5 V supply. Once you start running applications with the RedLab 1608FS, each DIO bit can draw up to 2.5 mA. The maximum amount of +5 V current available for experimental use, over and above that required by the RedLab 1608FS, is the difference between the total current requirement of the RedLab 1608FS (based on the application), and the allowed current draw of the computer platform (500 mA for desktop computers and self-powered hubs).

With all outputs at their maximum output current, you can calculate the total current requirement of the RedLab 1608FS USB +5 V as follows:

$$(\text{RedLab 1608FS @ 150 mA}) + (8 \text{ DIO @ 2.5 mA ea}) = 170 \text{ mA}$$

For an application running on a computer or powered hub, the maximum available excess current is  $500 \text{ mA} - 170 \text{ mA} = 330 \text{ mA}$ . This number is the total maximum available current at the PC+5 V screw terminals. Meilhaus Electronic highly recommends that you figure in a safety factor of 20% below this maximum current loading for your applications. A conservative, safe user maximum in this case would be in the 250-300 mA range.

Since some laptop computers running on battery power only allow up to 100 mA, the RedLab 1608FS may be above that allowed by the computer. In this case, you must either purchase a self-powered hub or operate the laptop computer from an external power adapter.

## Ground terminals

The 11 analog ground connections provide a common ground for all RedLab 1608FS input channels. Eight ground connections provide a common ground for the **DIO**, **TRIG\_IN**, **CTR**, **SYNC** and **PC +5 V** connections. Refer to the pinout diagram on page 3-16 for the location of the **AGND** and **GND** terminal pins.

## Calibration terminal

The **CAL** connection (pin 17) is an output you should use only to calibrate the RedLab 1608FS. Refer to the pinout diagram on page 3-16 for the location of this pin. Calibration of the RedLab 1608FS is software-controlled by *InstaCal*.

## Counter terminal

The **CTR** connection (pin 38) is a TTL-level input to a 32-bit event counter. Refer to the pinout diagram on page 3-16 for the location of this pin. The internal counter increments when the TTL level transitions from low to high. The counter can count frequencies of up to 1 MHz.

## SYNC terminal

The **SYNC** connection (pin 36) is a bidirectional I/O signal. You can use it for two purposes:

- Configure as an external clock input to externally source the A/D conversions. The SYNC terminal supports TTL-level input signals of up to 50 kHz.
- Configure as an output to synchronize with a second RedLab 1608FS and acquire data from 16 channels.

Refer to the pinout diagram on page 3-16 for the location of this pin. For more information, refer to page 3-23.

## Trigger terminal

The **TRIG\_IN** connection (pin 37) is an external digital trigger input. You can configure this terminal with software for either rising or falling edge.

## Accuracy

The overall accuracy of any instrument is limited by the error components within the system. Quite often, resolution is incorrectly used to quantify the performance of a measurement product. While "16-bits" or "1 part in 65536" does indicate what can be resolved, it provides little insight into the quality, or accuracy, of an absolute measurement. Accuracy specifications describe the actual measurement that can be relied upon with a RedLab 1608FS.

There are three types of errors which affect the accuracy of a measurement system:

- offset
- gain
- nonlinearity

The primary error sources in the RedLab 1608FS are offset and gain. Nonlinearity is small in the RedLab 1608FS, and is not significant as an error source with respect to offset and gain.

Figure 8 shows an ideal, error-free, RedLab 1608FS transfer function. The typical calibrated accuracy of the RedLab 1608FS is range-dependent, as explained in the "[Specifications](#)" chapter of this document. We use a  $\pm 10$  V range as an example of what you can expect when performing a measurement in this range.

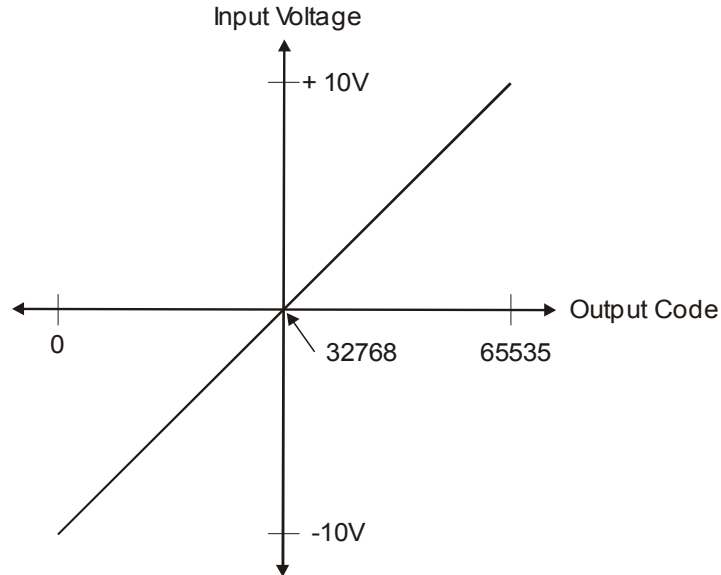

Figure 8. Ideal ADC transfer function

The RedLab 1608FS offset error is measured at mid-scale. Ideally, a zero volt input should produce an output code of 32768. Any deviation from this is an offset error. Figure 9 shows the RedLab 1608FS transfer function with an offset error. The typical offset error specification for the RedLab 1608FS on the  $\pm 10$  V range is  $\pm 1.66$  mV. Offset error affects all codes equally by shifting the entire transfer function up or down along the input voltage axis.

**The accuracy plots in Figure 9 are drawn for clarity and are not drawn to scale.**

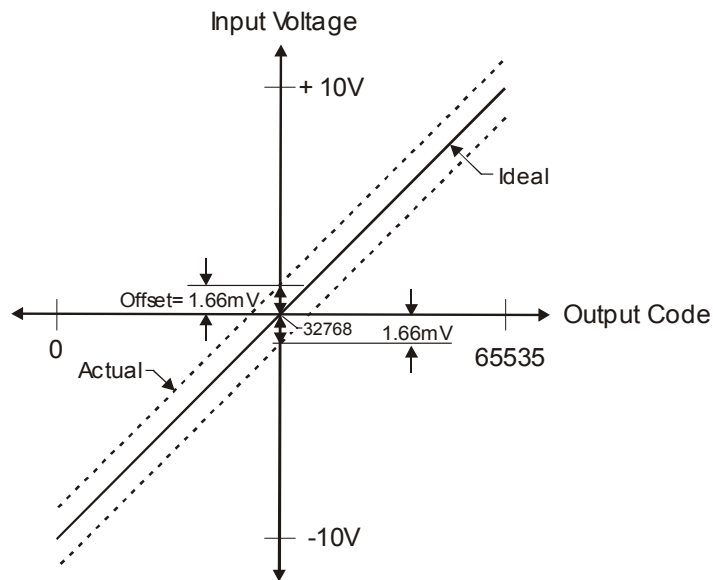

Figure 9. ADC transfer function with offset error

Gain error is a change in the slope of the transfer function from the ideal, and is typically expressed as a percentage of full-scale. Figure 10 shows the RedLab 1608FS transfer function with gain error. Gain error is easily converted to voltage by multiplying the full-scale input ( $\pm 10$  V) by the error.

**The accuracy plots in Figure 10 are drawn for clarity and are not drawn to scale.**

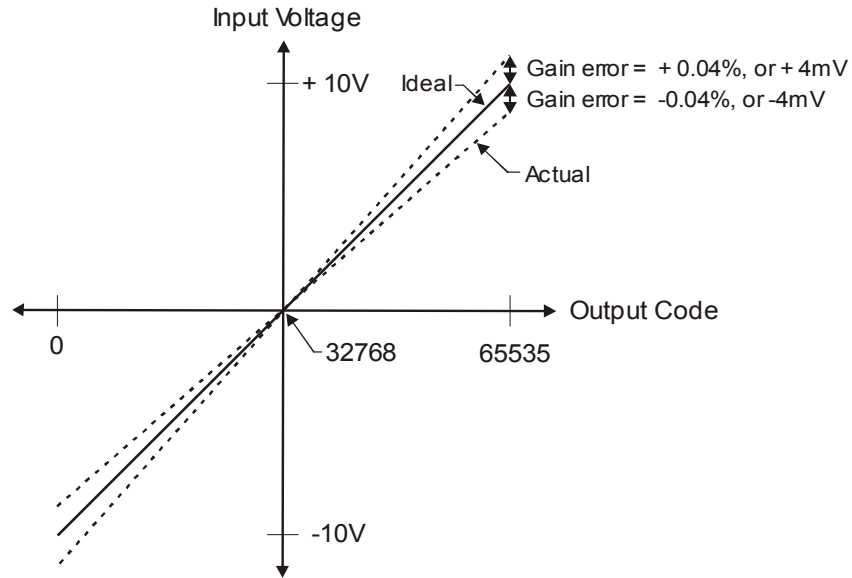

Figure 10. ADC Transfer function with gain error

For example, the RedLab 1608FS exhibits a typical calibrated gain error of  $\pm 0.04\%$  on all ranges. For the  $\pm 10$  V range, this would yield  $10 \text{ V} \times \pm 0.0002 = \pm 4 \text{ mV}$ . This means that at full scale, neglecting the effect of offset for the moment, the measurement would be within 4 mV of the actual value. Note that gain error is expressed as a ratio. Values near  $\pm \text{FS}$  ( $\pm 10$  V) are more affected from an absolute voltage standpoint than are values near mid-scale, which see little or no voltage error.

Combining these two error sources in Figure 11, we have a plot of the error band of the RedLab 1608FS at  $\pm$ full scale ( $\pm 10$  V). This plot is a graphical version of the typical accuracy specification of the product.

The accuracy plots in Figure 11 are drawn for clarity and are not drawn to scale.

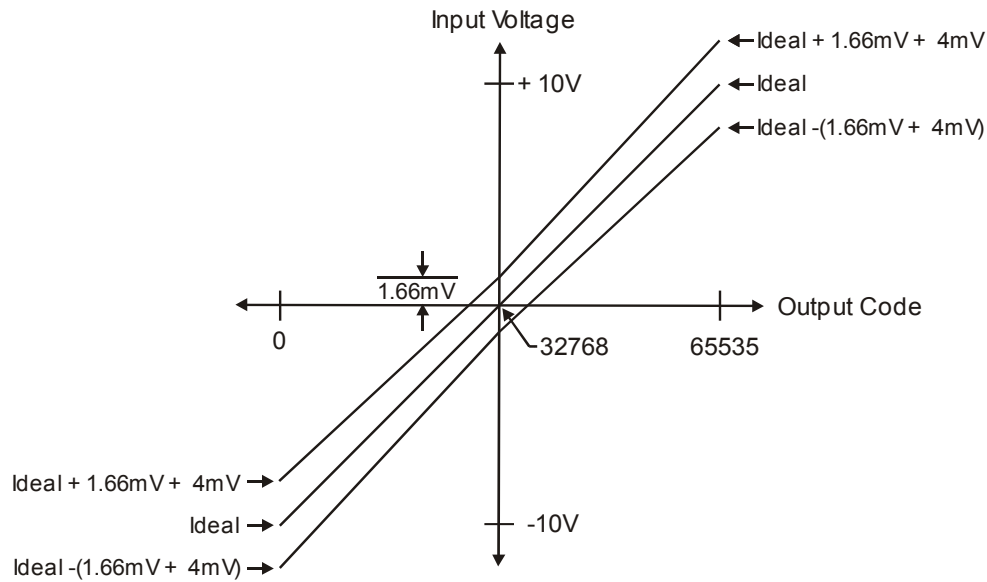

Figure 11. Error band plot

## Gain queue

The RedLab 1608FS gain queue allows you to set up a different gain setting for each channel. The gain queue removes the restriction of having a single gain for all channels. This feature creates a gain list which is written to local memory on the RedLab 1608FS. The gain list is made up of a channel number and range setting. An example of an eight-element list is shown in the table below.

Sample channel gain queue list

Element	Channel	Range
0	CH0	BIP10V
1	CH1	BIP5V
2	CH2	BIP10V
3	CH3	BIP1V
4	CH4	BIP2V
5	CH5	BIP10V
6	CH6	BIP1V
7	CH7	BIP5V

Note that the gain queue must contain eight elements that include all eight channels. You must carefully match the gain to the expected voltage range on the associated channel — otherwise, an over range condition can occur. Although this condition does not damage the RedLab 1608FS, it does produce a useless full-scale reading. It can also introduce a long recovery time due to saturation of the input channel.

## Synchronizing multiple units

You can connect the SYNC pin of two RedLab 1608FS units together in a master/slave configuration and acquire data synchronously from 16 channels. When the SYNC pin is configured as an output, the internal A/D pacer clock signal is sent to the screw terminal. You can output the clock to the SYNC pin of a second RedLab 1608FS configured for A/D pacer input.

You set the function of the SYNC pin (pin 36) for pacer input or pacer output by using *InstaCal*. By default, the SYNC pin is set for pacer input. To synchronize a master RedLab 1608FS with a slave RedLab 1608FS and acquire data from 16 channels, follow the steps below:

1. Run InstaCal.
  2. Double-click on the RedLab 1608FS listing on the **PC Board List** on the **InstaCal** main form. The **Board Configuration** dialog displays.
  3. Configure the SYNC pin of the master RedLab 1608FS for pacer output:
    - Double-click on the RedLab 1608FS that you want to configure as the master. The **Board Configuration** dialog opens.
    - Click to select the **Enable Sync output** check box and then click **OK**.
- Enable SYNC output
4. Configure the SYNC pin of the slave RedLab 1608FS for pacer input:
    - Double-click on the RedLab 1608FS that you want to configure as the slave. The **Board Configuration** dialog displays.
    - Make sure that the **Enable Sync output** check box is not checked (unchecked is the default setting).
- Enable SYNC output
5. Connect the SYNC pin on the master RedLab 1608FS to the SYNC pin on the slave RedLab 1608FS.
  6. Set the Universal Library EXTLOCK option with `cbAInScan()/AInScan()` for the slave RedLab 1608FS to enable pacer output.

An example of a master/slave configuration is shown below.

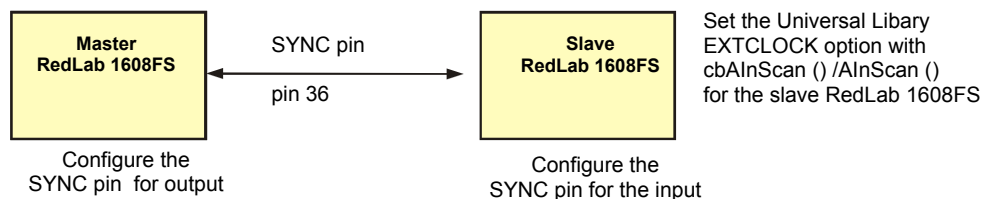

Figure 12. Configuring for synchronous data acquisition

When you are operating one RedLab 1608FS, do not set the `EXTLOCK` option unless you are using an external clock for A/D pacing.

## Specifications

Typical for 25 °C unless otherwise specified.

Specifications in *italic text* are guaranteed by design.

### Analog input section

Table 1. Analog input specifications

Parameter	Conditions	Specification
A/D converter type		16-bit successive Approximation type
Number of channels		8 single-ended
Input configuration		Individual A/D per channel
Sampling method		Simultaneous
<i>Absolute maximum input voltage</i>	<i>CHx IN to GND.</i>	<i>±15 V max</i>
Input impedance		100 MOhm, min
Input ranges	Software selectable	±10 V, ±5 V, ±2 V, ±1 V
Sampling rate	Scan to PC memory	0.6 S/s to 50 kS/s, software programmable
	Burst scan to 32 k sample FIFO	20 S/s to 50 kS/s, software programmable
Throughput	Software paced	500 S/s all channels
	Scan to PC memory (Note 1)	= (100 kS/s) / (# of channels), max of 50 kS/s for any channel
	Burst scan to 32 k sample FIFO	= (200 kS/s) / (# of channels), max of 50 kS/s for any channel
Gain queue		Software configurable. Eight elements, one gain element per channel.
Resolution		16 bits
<i>No missing codes</i>		<i>15 bits</i>
Crosstalk	Signal DC-25 KHz	-80 dB
CAL output	User calibration source	0.625 V, 1.25 V, 2.5 V, 5.0 V, software selectable
CAL output accuracy (Note 2)		±0.5% typ, ±1.0% max
CAL current		±5 mA max
Trigger source	Software selectable	External digital: TRIG_IN

**Note 1:** Maximum throughput scanning to PC memory is machine dependent. While the majority of XP equipped PC's we tested allowed acquisition at the maximum rates, a few would not. The lowest maximum rate we observed on an XP equipped PC during multi-channel testing was 95 kS/s, aggregate. The rates specified are for Windows XP only. Maximum rates on operating systems that predate XP may be less and must be determined through testing on your machine.

**Note 2:** Actual values used for calibration are measured and stored in EEPROM.

Table 2. Calibrated absolute accuracy

Range	Accuracy (mV)
±10 V	5.66
±5 V	2.98
±2 V	1.31
±1 V	0.68

Table 3. Accuracy components - All values are (±)

Range	% of Reading	Gain error at FS (mV)	Offset (mV)
±10 V	0.04	4.00	1.66
±5 V	0.04	2.00	0.98
±2 V	0.04	0.80	0.51
±1 V	0.04	0.40	0.28

Table 4 summarizes the noise performance for the RedLab 1608FS. Noise distribution is determined by gathering 50 K samples with inputs tied to ground at the user connector. Samples are gathered at the maximum specified sampling rate of 50 kS/s.

Table 4. Noise performance

Range	Typical counts	LSBrms
±10 V	10	1.52
±5 V	10	1.52
±2 V	11	1.67
±1 V	14	2.12

## Digital input/output

Table 5. Digital I/O specifications

Digital type	CMOS
Number of I/O	8 (DIO0 through DIO7)
Configuration	Independently configured for input or output
Pull-up/pull-down configuration	All pins pulled up to $V_s$ via 47 K resistors (default). Positions available for pull down to ground. Hardware selectable via zero ohm resistors as a factory option.
Input high voltage	2.0 V min, 5.5 V absolute max
Input low voltage	0.8 V max, -0.5 V absolute min
Output high voltage ( $I_{OH} = -2.5$ mA)	3.8 V min
Output low voltage ( $I_{OL} = 2.5$ mA)	0.7 V max
Power on and reset state	Input

## External trigger

Table 6. External trigger specifications

Parameter	Conditions	Specification
Trigger source (Note 3)	External digital	TRIG_IN
Trigger mode	Software selectable	Edge sensitive: user configurable for CMOS compatible rising or falling edge.
Trigger latency		10 $\mu$ s max
Trigger pulse width		1 $\mu$ s min
Input high voltage		4.0 V min, 5.5 V absolute max
Input low voltage		1.0 V max, -0.5 V absolute min
<i>Input leakage current</i>		$\pm 1.0 \mu A$

**Note 3:** TRIG\_IN is a Schmitt trigger input protected with a 1.5K Ohm series resistor.

## External clock input/output

Table 7. External clock I/O specifications

Parameter	Conditions	Specification
Pin name		SYNC
Pin type		Bidirectional
Software selectable direction	Output	Outputs internal A/D pacer clock.
	Input	Receives A/D pacer clock from external source.
Input clock rate		50 kHz, maximum
Clock pulse width	Input	1 $\mu$ s min
	Output	5 $\mu$ s min
<i>Input leakage current</i>		$\pm 1.0 \mu A$
Input high voltage		4.0 V min, 5.5 V absolute max
Input low voltage		1.0 V max, -0.5 V absolute min
Output high voltage (Note 4)	IOH = -2.5 mA	3.3 V min
	No load	3.8 V min
Output low voltage (Note 4)	IOL = 2.5 mA	1.1 V max
	No Load	0.6 V max

**Note 4:** SYNC is a Schmitt trigger input and is over-current protected with a 200 Ohm series resistor.

## Counter section

Table 8. Counter specifications

Pin name (Note 5)	CTR
Counter type	Event counter
Number of channels	1
Input type	TTL, rising edge triggered
Input source	CTR screw terminal
Resolution	32 bits
<i>Schmitt trigger hysteresis</i>	<i>20 mV to 100 mV</i>
<i>Input leakage current</i>	$\pm 1\mu A$
Maximum input frequency	1 MHz
<i>High pulse width</i>	<i>500 ns min</i>
<i>Low pulse width</i>	<i>500 ns min</i>
Input high voltage	4.0 V min, 5.5 V absolute max
Input low voltage	1.0 V max, -0.5 V absolute min

**Note 5:** CTR is a Schmitt trigger input protected with a 1.5K Ohm series resistor.

## Memory

Table 9. Memory specifications

Data FIFO	32,768 samples, 65,536 bytes		
EEPROM	1,024 bytes		
EEPROM configuration	<b>Address range</b>	<b>Access</b>	<b>Description</b>
	0x000-0x07F	Reserved	128 bytes system data
	0x080-0x1FF	Read/write	384 bytes cal data
	0x200-0x3FF	Read/write	512 bytes user area

## Microcontroller

Table 10. Microcontroller specifications

<i>Type</i>	<i>High performance 8-bit RISC microcontroller</i>
<i>Program memory</i>	<i>16,384 words</i>
<i>Data memory</i>	<i>2,048 bytes</i>

## Power

Parameter	Conditions	Specification
Supply current	USB enumeration	< 100 mA
Supply current (Note 6)	Continuous mode	150 mA
+5 V USB power available (Note 7)	Connected to self-powered hub Connected to externally-powered root port hub	4.5 V min, 5.25 V max
Output current (Note 8)		350 mA max

**Note 6:** This is the total current requirement for the RedLab 1608FS which includes up to 10 mA for the status LED.

**Note 7:** "Self-powered hub" refers to a USB hub with an external power supply. Self-powered hubs allow a connected USB device to draw up to 500 mA. "Root port hubs" reside in the PC's USB host Controller. The USB port(s) on your PC are root port hubs. All externally-powered root port hubs (desktop PC's) provide up to 500 mA of current for a USB device. Battery-powered root port hubs provide 100 mA or 500 mA, depending upon the manufacturer. A laptop PC that is not connected to an external power adapter is an example of a battery-powered root port hub. If your laptop PC is constrained to the 100 mA maximum, you need to purchase a self-powered hub.

**Note 8:** This refers to the total amount of current that can be sourced from the USB +5 V and digital outputs.

## General

Device type	USB 2.0 (full-speed)
Device compatibility	USB 1.1, USB 2.0

## Environmental

Operating temperature range	0 to 70 °C
Storage temperature range	-40 to 70 °C
Humidity	0 to 90% non-condensing

## Mechanical

Dimensions	79 mm (L) x 82 mm (W) x 25 mm (H)
USB cable length	3 meters max
User connection length	3 meters max

## Main connector and pin out

Connector type	Screw terminal
Wire gauge range	16 AWG to 30 AWG

Pin	Signal Name	Pin	Signal Name
1	CH0 IN	21	DIO0
2	AGND	22	GND
3	CH1 IN	23	DIO1
4	AGND	24	GND
5	CH2 IN	25	DIO2
6	AGND	26	GND
7	CH3 IN	27	DIO3
8	AGND	28	GND
9	CH4 IN	29	DIO4
10	AGND	30	GND
11	CH5 IN	31	DIO5
12	AGND	32	GND
13	CH6 IN	33	DIO6
14	AGND	34	GND
15	CH7 IN	35	DIO7
16	AGND	36	SYNC
17	CAL	37	TRIG IN
18	AGND	38	CTR
19	AGND	39	PC +5V
20	AGND	40	GND

**Meilhaus Electronic GmbH**  
**Fischerstrasse 2**  
**D-82178 Puchheim, Germany**  
**Phone: +49 (0)89 89 01 66-0**  
**Fax: +49 (0)89 89 01 66-77**  
**E-Mail: [sales@meilhaus.com](mailto:sales@meilhaus.com)**  
**<http://www.meilhaus.com>**