



Intelligent sensor

THT2

Humidity measuring range: 0 to 100 %

Temperature measuring range: -40 to +123.8 °C

Dew point automatic calculation

Communication via RS485 line



THT2 I

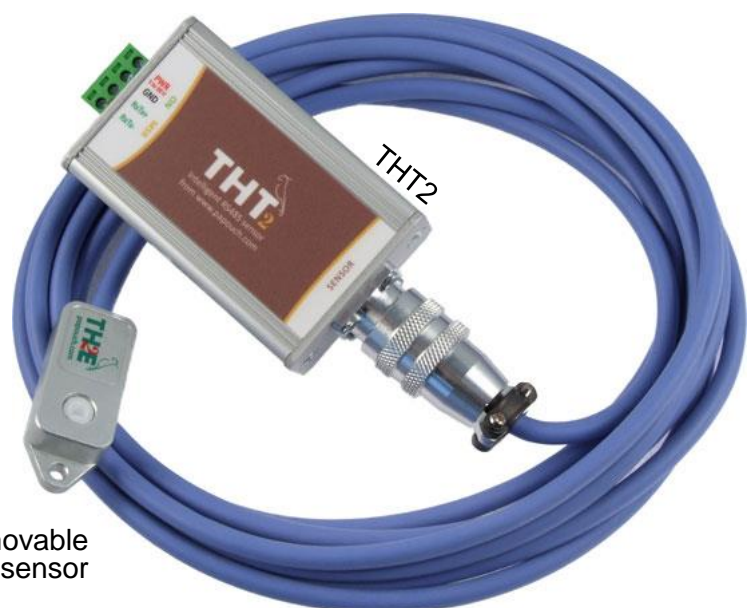

Removable
sensor

THT2

Datasheet

Created: 6.4.2009

Last update: 18.12.2015 13:02

Number of pages: 16

© 2015 Papouch s.r.o.

Papouch s.r.o.

Address:

**Strasnicka 3164
102 00 Prague 10
Czech Republic**

Tel:

+420 267 314 267

Fax:

+420 267 314 269

Internet:

www.papouch.com

E-mail:

info@papouch.com



LIST OF CONTENTS

Basic information	4
Available models.....	4
Main features	5
Detailed features.....	5
Design	6
Connection.....	8
Indication	10
THT2.....	10
THT2 I.....	10
Technical parameters	10
Integrated temperature and humidity sensor	10
Temperature Sensor	12
Other parameters.....	13
Electronics	13
Available designs	14
Communication protocol	14

BASIC INFORMATION

THT2 is an intelligent hygrometer and thermometer. It measures **humidity** directly in percentage and **temperature** in degrees Celsius. Also, it is able to combine both values to calculate the **dew point**. It uses an external sensor connected via a cable.¹ It is possible to connect either an **integrated temperature and humidity sensor** or just a **separate temperature sensor** (see below). Values in digital format are made available via the RS485 communication line.

THT2 has low consumption – it is easy to create a network of these devices connected via a single four-wire cable (RS485 + power supply) ranging up to 1200 meters.

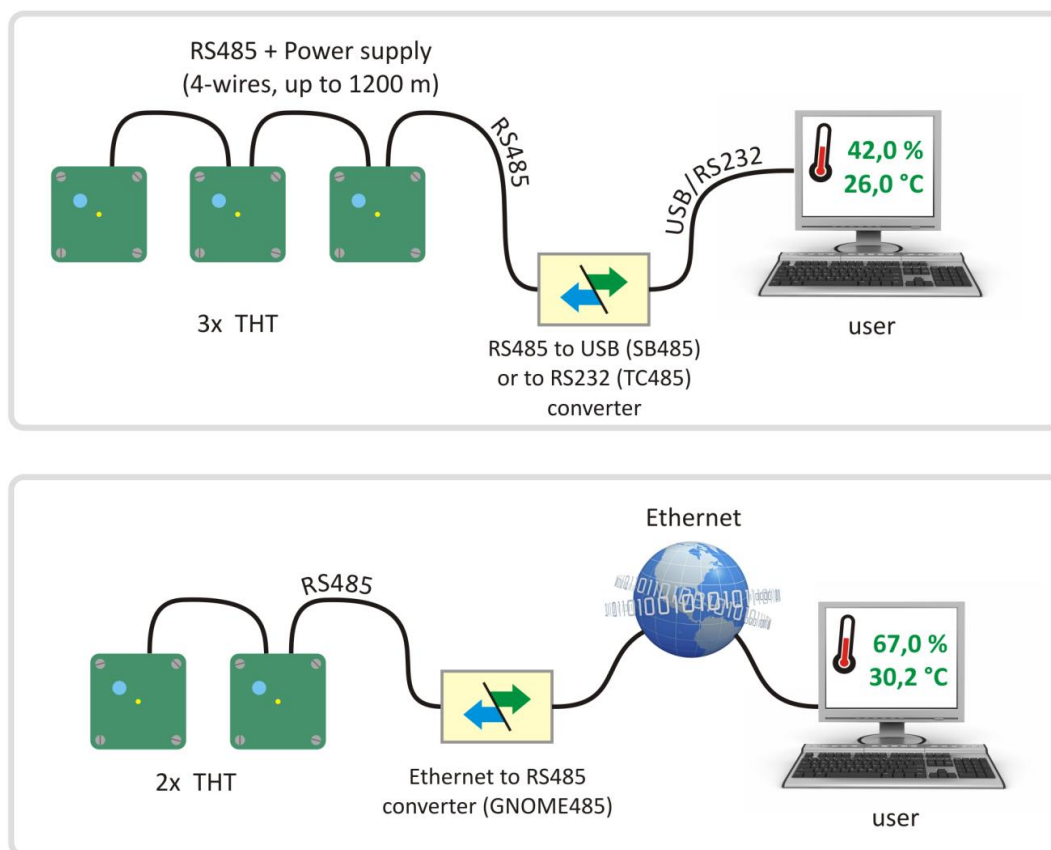

Fig. 1 – Example of THT2 sensors connection to PC (directly or over Ethernet)

Available models

THT2

Electronics in an enclosure to be connected to an external sensor. Sensor is sold separately. These types are available:

- Temperature and humidity sensor** or
- Temperature sensor** only.

THT2 I

- Electronics with temperature and humidity sensor within interior enclosure.



¹ The sensor is not included in the price – it is supplied separately, please, specify when making your order.

Main features

- Measures relative humidity within the range of 0 % to 100 %.²
- Measures temperature within the range of -40 to +123.8 °C or -55 to +125.0 °C.²
- Dew point calculation.²
- Sensor connected with the electronics via a silicon highly durable cable.²
- Temperature conversion into several temperature units.
- Extreme values memory option – THT2 remembers the highest and lowest measured value for each measured physical quantity.
- Connection and communication via the RS485 bus (connection using only two conductors for the distance of up to 1.2 km).
- Spinel and MODBUS RTU communication protocols.
- Free Wix software for Windows.
- Power supply: 5 V to 30 V.
- Mountable on DIN 35 mm rail.

Detailed features

Measurement

- Measures temperature, humidity and dew point or just temperature based on the type of connected sensor.
- Memorizes extreme values for each measured physical quantity. One entry for the historically highest measured value and one for the lowest measured value.
- Possibility to set the upper and lower limit for each physical quantity. Whenever exceeding the preset range the device sends an automatic message.
- The possibility to activate value monitoring separately for each physical quantity.
- Temperature units: Celsius, Fahrenheit or Kelvin.
- Possibility to set hysteresis for measurements carried out at locations with fluctuating values.

Hardware

- Measures relative humidity within the range of 0 % to 100 %.
- Measures temperature within the range of -40 to +123.8 °C or -55 to +125.0 °C.
- Dew point calculation.
- THT2: Silicon cable (up to 20m) with metal sensor at its end.
- THT2 I: Interior model with integrated sensor.
- Power supply: 5 to 30 V

² Depending on the type of connected sensor. (The sensor is not included in the price – it is supplied separately, please, specify when making your order.)

Design

Electronics

- THT2: In a metal box made of anodized aluminum.
- THT2 I: Plastic enclosure with all-around vents, embedded temperature and humidity sensor.

Sensor

- THT2: Integrated humidity and temperature sensor (+ dew point calculation) – in a 40 × 16 × 10 mm metal box.
Cable: Silicon; diameter 4.3 mm; length 3m (max. 20 m); thermal resistance -60 to +200 °C; blue color.



Fig. 2 – Integrated humidity and temperature sensor

- THT2: Temperature sensor only – in a standardized stainless steel tip – 6 mm in diameter, 60 mm long.
Cable: Silicon; diameter 4.3 mm; length 3m (max. 20 m); thermal resistance -60 to +200 °C; blue color.



Fig. 3 – Temperature sensor

- THT2 I: Integrated temperature and temperature sensor (+ dew point calculation)



fig. 4 – Interior model THT2 I

Mounting (THT2 only)

- Without a mounting clip (*standard design*)
- With a mounting clip for 35 mm DIN rail



Fig. 5 – THT2 with a mounting clip for 35 mm DIN rail

Supply

- 5 to 30 V DC

Do not hesitate to contact us if you have any other special requirements concerning the design and functions of the THT2 sensor.

CONNECTION

- 1) *THT2 only*: Connect the temperature or temperature/humidity sensor.
- 2) In most cases, shielded TP cable (so called STP or FTP cable – standard cable used in computer networks) will be fully sufficient as interconnector.

This cable contains four pairs of twisted conductors:

Use the first pair for data. One wire shall be **RxTx+**, the other one **RxTx-**.

The second pair: interconnect both conductors and use them for the positive pole of the power supply (**PWR**).

The third pair: interconnect both conductors and use them for power supply grounding (**GND**).

The fourth pair: Leave unconnected. As a backup for any future use.

If more THT devices are to be connected via the RS485 line, connect the cable in the way as illustrated below – i.e. one module after the other. The total length of the cable can reach up to 1200 meters.

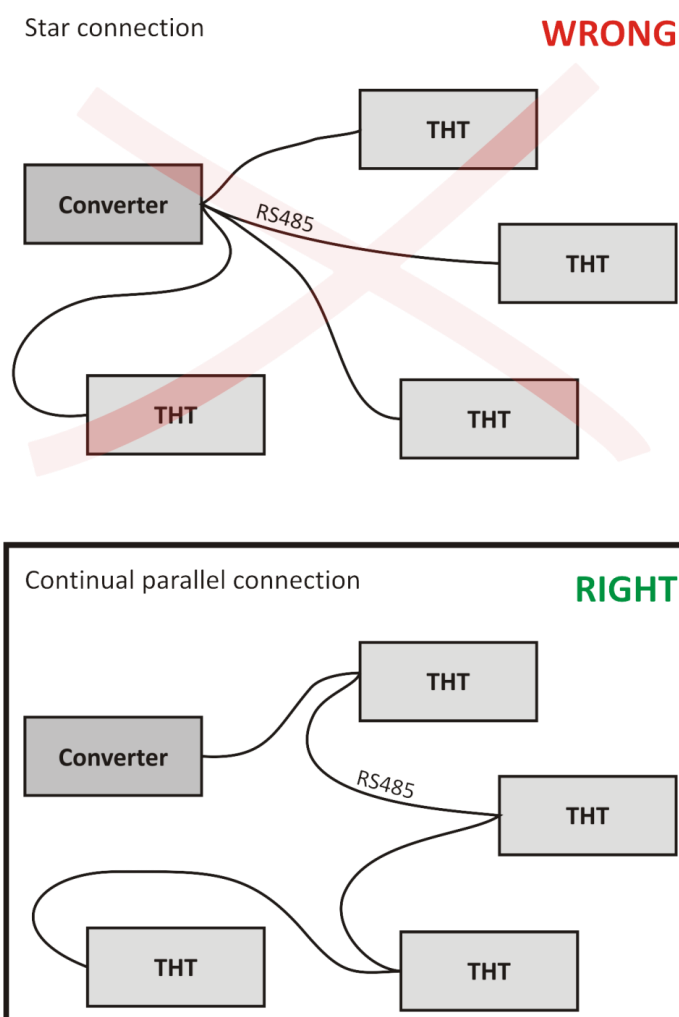

Fig. 6 – Incorrect and correct method of connecting a higher number of THT2 devices via RS485

Connect the terminal block (bus) for RS485 and power supply. Wires are connected to THT2 via a removable terminal block with screws:



Fig. 7 – Connectors on the electronics board

THT2 I has two separate terminals:



Fig. 8 – THT2 I terminals

PWR.....Power supply positive pole.

GND.....Power supply grounding.

RxTx+More positive wire of the RS485 communication line (can also be marked A)

RxTx-More negative wire of the RS485 communication line (can also be marked B)

- 3) THT2 I only: When the sensor is mounted on a wall, make sure one of the two arrows marked TOP aims straight upwards.
- 4) With other devices the RS485 communication lines shall be connected 1:1, i.e. RxTx+ on THT2 to RxTx+ of the other device and RxTx- to RxTx- respectively.

An example of a connection between a THT2, GNOME485³ converter and any other additional devices is shown in the following figure.

³ RS485 to Ethernet converter. It can be used to connect the sensors to a computer network and even to the Internet and thus to collect data from any place connectable to the Internet. For more information about GNOME485 converter visit www.papouch.com.

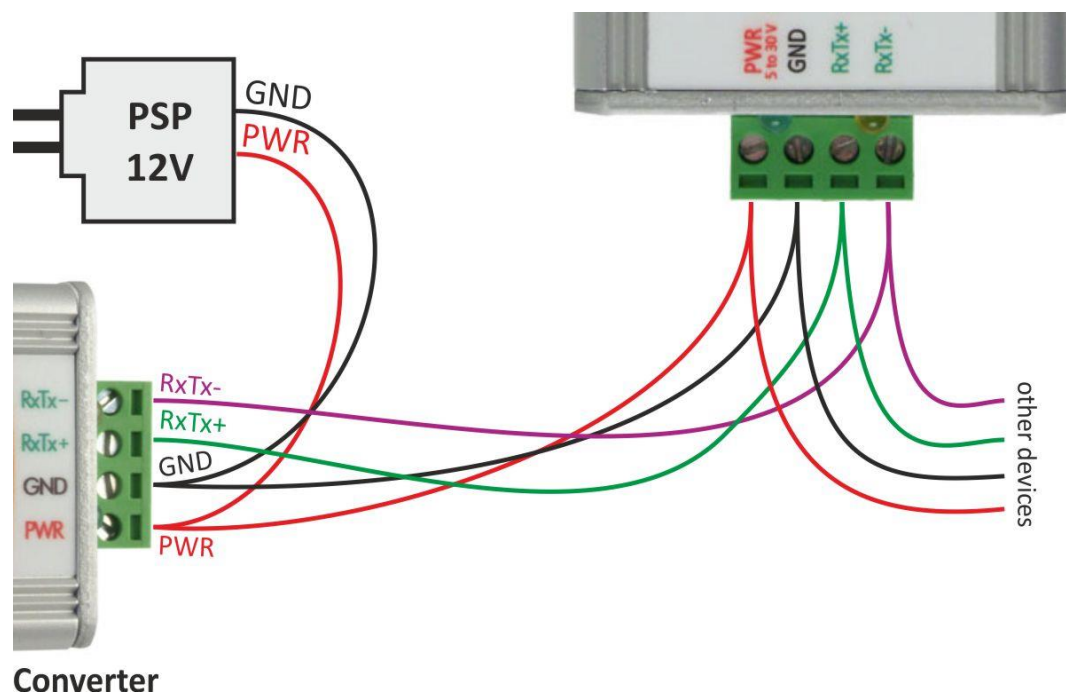

Fig. 9 – Example of a connection between a converter, THT2 and other devices

INDICATION

THT 2

Green LED indicator

The light glows when the device is connected to power supply.

Yellow LED indicator

The light flashes briefly to indicate correct initiation. The light also flashes to indicate communication via RS485.

THT2 I

All OK: LED is **green** and **flashes red** when THT2 I communicates.

Sensor error: LED is **red** and **flashes green** when THT2 I communicates.

TECHNICAL PARAMETERS

Integrated temperature and humidity sensor

Degree of protection.....	IP 54
Dimensions	40 × 16 × 10 mm, aluminum box
Cover material.....	hardened duralumin

Humidity Sensor

Humidity measuring range	0 % to 100 % RH
Increments	1% RH
Measuring repeatability	± 0.1 % RH
Temperature stability.....	typically 0.5 % RH per year

Measuring elementpolymer sensor

Sensor positionunder the plastic grid in the upper part of the device

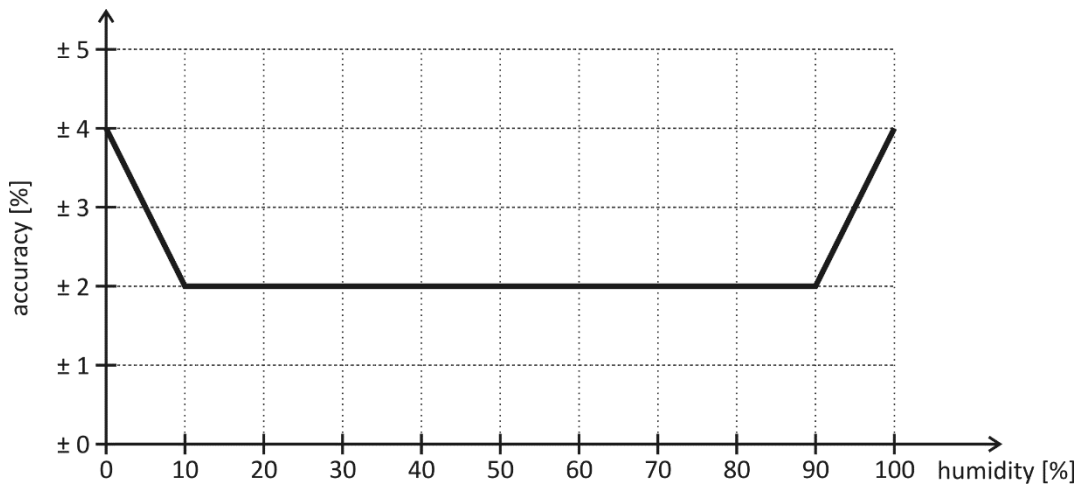

Fig. 10 – accuracy of humidity measuring

Temperature Sensor

Temperature measuring range-40.0 °C to +123.8 °C ⁴

Resolution0.1 °C

Measuring repeatability± 0.1 °C

Measuring elementsemiconductor sensor

Sensor positionunder the plastic grid in the upper part of the device

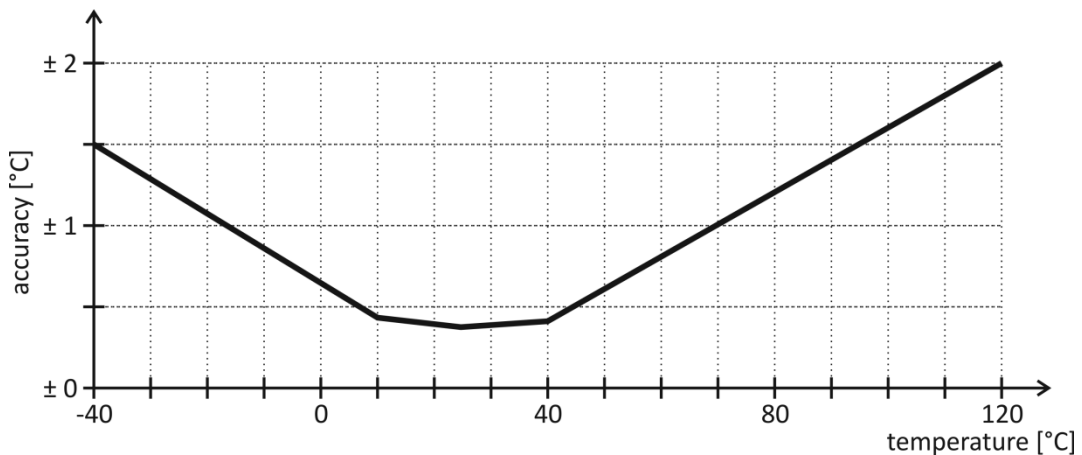

Fig. 11 – temperature measuring accuracy for THT2 sensor

⁴ Interior model up to 70 °C – plastic box limitation.

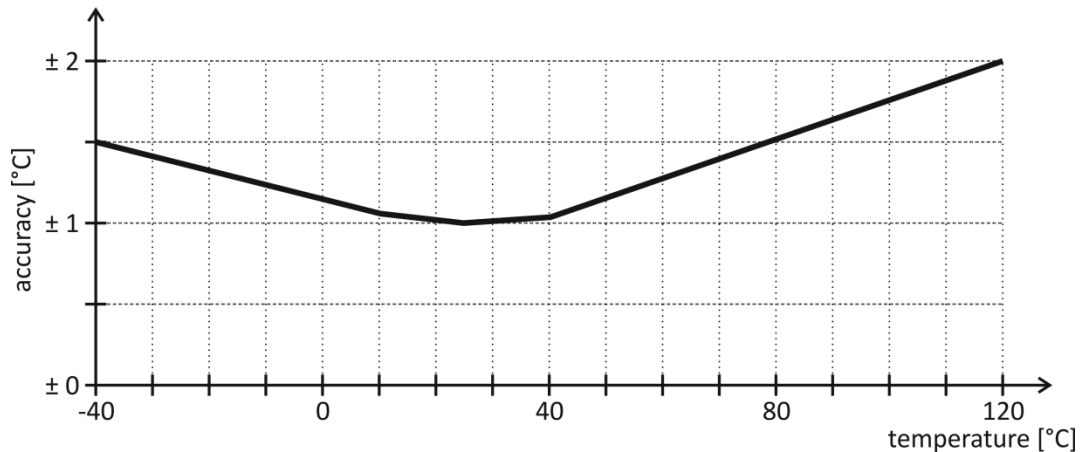

Fig. 12 – temperature measuring accuracy for THT2 I sensor

Operating and Maximum Range of Values

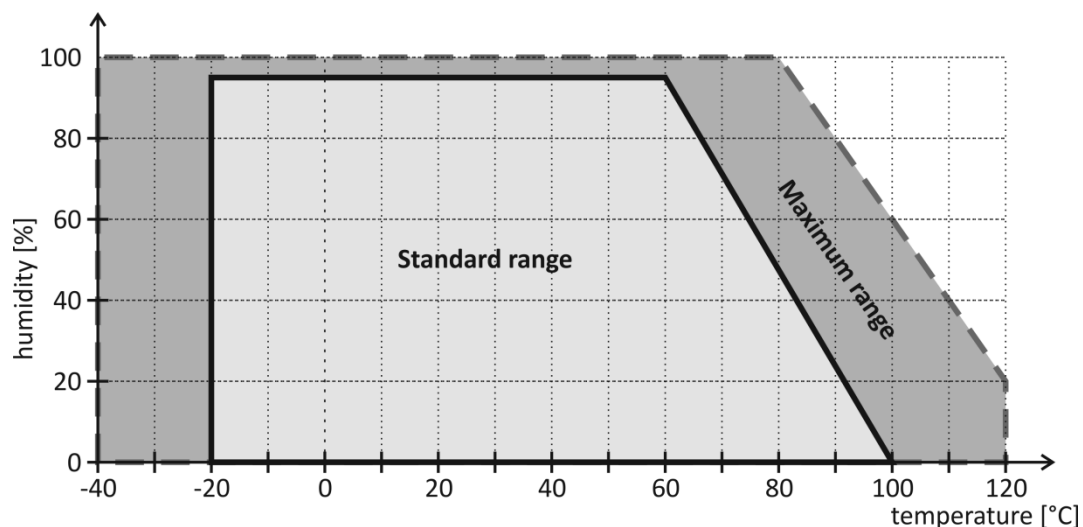

Fig. 13 – working and maximum temperature range

- Sensor is stable in standard range of values (see Fig. 13). Long-term exposure to conditions outside these values (humidity above 80% in particular) can temporarily shift the measured-out values (by +3% for 60 hours). When the sensor is back to standard ranges, it returns to its pre-calibrated state slowly.⁵
- Long-term exposure to extreme conditions or to chemically aggressive vapor can speed up the aging process of the sensor significantly. It can also shift the measurements.

Temperature Sensor

Type of sensor semiconductor

Range of measured temperature -55 °C to +125 °C ⁴

Accuracy ±0,5 °C in the range -10 °C to +85 °C; otherwise ±2 °C

Temperature drift ±0,2 °C in 1000 hours at 125 °C

⁵ You can speed up this process by doing following:

- 1) Leave the sensor in environment above 100 to 105 °C and humidity below 5 % for at least 10 hours.
- 2) Leave the sensor in environment above 20 to 30 °C and humidity approximately 75 % for around 12 hours. (Humidity 75% can be achieved with saturated solution of NaCl.)

Dimensions.....	standardized diameter of 6 mm, 60 mm long
Cover material	anodized aluminum
Degree of protection	IP 68 (permanent immersion to the depth of 1 m max.)

Other parameters

Sensor cable

Jacket.....	silicon rubber, blue
Wire insulation	FEP polymer
Standard length	3 m (up to 20 m upon request)
Range of temperatures – permanent.....	-60 °C to +200 °C
Maximum permissible temperature.....	+220 °C
Cable diameter	4.3 mm (±0.1 mm)

The cable shows great resistance against humidity, chemical substances and hydrocarbons.

Electronics

Communication

Communication line	RS485
Protocols.....	Spinel, MODBUS RTU
Default protocol	Spinel
Default address in Spinel protocol	31H (“1”)
Default communication speed	9600 Bd
Adjustable communication speeds	110, 300, 600, 1 200, 2 400, 4 800, 9 600, 19 200, 38 400, 57 600, 115 200 and 230 400 Bd
Data bits number	8
Parity	no parity
Stop-bits number	1
Termination.....	No, only 22 kΩ resistors defining the idle status

THT2 only

Dimensions.....	41.5 × 24 × 72 mm
Weight	75 g
Wire connection.....	removable terminal block (bus) with screws
Power consumption	typ. 8 mA @ 12 V

THT2 I only

Dimensions.....	62 × 62 × 28 mm
Weight	50 g
Mounting holes	2.8mm diameter, two oval holes
Wire connection.....	screw on terminal

Power consumption..... typ. 1.7 mA @ 12 V
typ. 840 μ A @ 30 V

Other Parameters

Electronics operating temperature -40 °C to 85 °C

Power supply 5 V to 30 V DC

Polarity reversal protection..... yes

Available designs

Holder:

- Without a holder (*standard design*)
- With a mounting clip for 35 mm DIN rail

Do not hesitate to contact us in case of any other special requirements concerning the THT2 module design and functions.

COMMUNICATION PROTOCOL

The THT2 module is equipped with standardized Spinel protocol (formats 66 and 97) and MODBUS RTU.

The detailed description of both Protocols protocol used by THT2, including described examples, can be found on www.papouch.com.

Papouch s.r.o.

Data transmission in industry, line and protocol conversions, RS232/485/422/USB/Ethernet/GPRS/WiFi, measurement modules, intelligent temperature sensors, I/O modules, and custom-made electronic applications.

Address:

**Strasnicka 3164
102 00 Prague 10
Czech Republic**

Tel:

+420 267 314 267

Fax:

+420 267 314 269

Internet:

www.papouch.com

E-mail:

info@papouch.com

